

# LIVING LIGHT

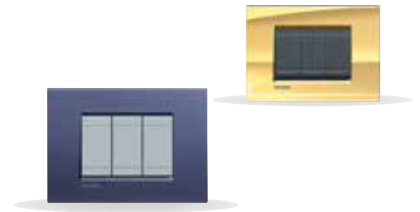

THE VALUE OF DESIGN... FOR YOU

# LIVINGLIGHT



A SINGLE SERIES

THREE FINISHES OF THE KEYS  
white, tech, anthracite

TWO DESIGNS OF COVER PLATE  
Air, Square

COUNTLESS COMBINATIONS



SQUARE COVER PLATE



LIGHT AIR COVER PLATE



LIGHT AIR COVER PLATE

Livinglight - One for all, all for you

# BASIC CONTROL

		NEUTRAL LIGHTABLE KEY COVERS		
		1 module	2 modules	3 modules
Description		Item	Item	Item
NEUTRAL KEY COVER WITH LIGHTABLE DIFFUSER		N4915N	N4915M2N	N4915M3N
		NT4915N	NT4915M2N	NT4915M3N
		L4915N	L4915M2N	L4915M3N



## NEUTRAL CONTROLS

1 WAY SWITCH 1P 16 AX 250Vac	2 WAY SWITCH 1P 16 AX 250Vac	4 WAY SWITCH 1P 16 AX 250Vac	PUSH BUTTON 1P (NO) 10 A 250Vac
L4001/0	L4003/0	LN4004	L4005/0



## KEY COVERS FOR ROCKER CONTROLS

		METAL KEY COVER WITH LIGHTABLE BOTTOM SECTION 4 FINISHES FOR USE WITH SQUARE METALS COVER PLATES		
		1 module	2 modules	3 modules
Finish description		Item	Item	Item
ICE GOLD	○	LN49310A	LN4931M20A	LN4931M30A
BRONZE	○	LN4931BZ	LN4931M2BZ	LN4931M3BZ
NICKEL	○	LN4931NS	LN4931M2NS	LN4931M3NS
SILVER	○	LN4931AG	LN4931M2AG	LN4931M3AG

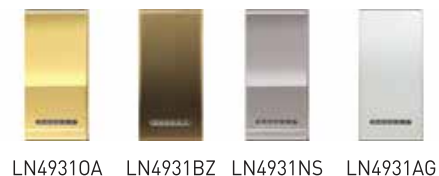

## CUSTOMIZED KEY COVER

Key cover with 3 zones to be customized

	1 Module	2 Modules	3 Modules
1 Module	N4915NC	N4915M2NC	N4915M3NC
	NT4915NC	NT4915M2NC	NT4915M3NC
	L4915NC	L4915M2NC	L4915M3NC

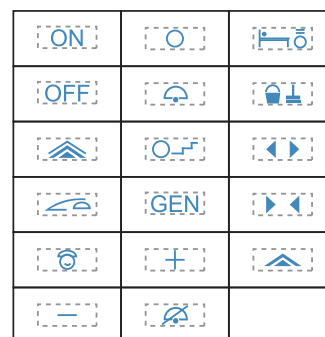
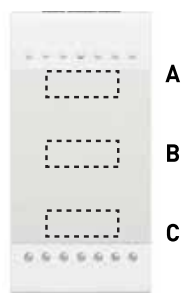

# OTHER CONTROL DEVICES



N4002N N4012 N4011



NT4022 NT4027 NT4016 L4461N



L4038R L4038V N4033 L4037



LN4040 26108L IP55 NT4341/34 NT4330/230

Item	16 AX 250 Va.c. SWITCHES
<input type="checkbox"/> N4002N <input type="checkbox"/> NT4002N <input type="checkbox"/> L4002N	2 P switch
<input type="checkbox"/> N4002 <input type="checkbox"/> NT4002 <input type="checkbox"/> L4002	2P key switch - the key can be removed both in the ON and in the OFF position - keys are different from each other
<input type="checkbox"/> N4002C* <input type="checkbox"/> NT4002C* <input type="checkbox"/> L4002C*	2P key switch - as above - keys are the same for all devices
*NOTE: item available to order. Contact your supplier for availability	
32 A DOUBLE POLE SWITCH	
<input type="checkbox"/> N4011 <input type="checkbox"/> NT4011 <input type="checkbox"/> L4011	32 A - 250Va.c. 2P switch
16 AX 250 Va.c. TWO WAY SWITCH	
<input type="checkbox"/> N4022 <input type="checkbox"/> NT4022 <input type="checkbox"/> L4022	1P key two-way switch - the key can be removed both in the ON and in the OFF position - keys are different from each other
<input type="checkbox"/> N4022C* <input type="checkbox"/> NT4022C* <input type="checkbox"/> L4022C*	1P key two-way switch - as above - keys are the same for all devices
*NOTE: item available to order. Contact your supplier for availability	
ROTARY SWITCH	
<input type="checkbox"/> N4016 <input type="checkbox"/> NT4016 <input type="checkbox"/> L4016	selector - 1 way rotary switch - 4 positions for controlling air conditioners, fans control, etc. - 3 A 250 Va.c.
TIMERS	
<input type="checkbox"/> N4461N <input type="checkbox"/> NT4461N <input type="checkbox"/> L4461N	1 to 12 minute adjustable electronic timer-pushbuttons remote control - power supply 230Va.c. - 6 A resistive / 2 A inductive 230Va.c. output contact

Item	10A 250 Va.c. PUSH BUTTONS
<input type="checkbox"/> N4036 <input type="checkbox"/> NT4036 <input type="checkbox"/> L4036	1P (NO) + 1P (NO) double pushbutton
<input type="checkbox"/> N4037 <input type="checkbox"/> NT4037 <input type="checkbox"/> L4037	1P (NO) + 1P (NO) interlocked double pushbutton
<input type="checkbox"/> N4033 <input type="checkbox"/> NT4033 <input type="checkbox"/> L4033	1P (NO) cord pushbutton
<input type="checkbox"/> N4038R <input type="checkbox"/> NT4038R <input type="checkbox"/> L4038R	1P (NO) pushbutton + lampholder for LEDs item LN4742V12T - LN4742V127T - LN4742V230T -red diffuser
<input type="checkbox"/> N4038V <input type="checkbox"/> NT4038V <input type="checkbox"/> L4038V	as above - green diffuser
<input type="checkbox"/> LN4040	1P (NO) pushbutton + lightable nameplate with LEDs item LN4742V12T - LN4742V127T - LN4742V230T
<input type="checkbox"/> N4042N <input type="checkbox"/> NT4042N <input type="checkbox"/> L4042N	1P (NO) pushbutton marked with lightable bell symbol
<input type="checkbox"/> N4042M2N <input type="checkbox"/> NT4042M2N <input type="checkbox"/> L4042M2N	1P (NO) pushbutton marked with lightable bell symbol - 2 modules
<input type="checkbox"/> 26108N <input type="checkbox"/> 26108T <input type="checkbox"/> 26108L	IP55 nameplate pushbutton - backlit with LED technology (included) - suitable for installation on 503E and 502E flush mounted boxes
MONOSTABLE RELAYS	
<input type="checkbox"/> N4330/230 <input type="checkbox"/> NT4330/230 <input type="checkbox"/> L4330/230	monostable relay with NO/NC contact 250 Va.c. 10A (resistive) 4A (inductive) cos 0.5 coil power supply 230Va.c.
ELECTRONICALLY HELD CYCLIC RELAYS	
<input type="checkbox"/> N4341/34 <input type="checkbox"/> NT4341/34 <input type="checkbox"/> L4341/34	circuit breaker cyclic relay 10 AX 250Va.c. - 3/4 wires



## SOCKET OUTLETS



Item		EURO-US STANDARD
<input type="checkbox"/> N4029S <input type="checkbox"/> NT4029S <input type="checkbox"/> L4029S		2P+E 15A 127/250 Va.c. socket - unshielded tulip contacts - 1 module
<input type="checkbox"/> N4025 <input type="checkbox"/> NT4025 <input type="checkbox"/> L4025		2P 16 A 127/250 Va.c. socket - Ø 5 mm shielded tulip contacts - 1 module
<input type="checkbox"/> N4026 <input type="checkbox"/> NT4026 <input type="checkbox"/> L4026		2P+E 16 A 127/250 Va.c. universal duplex socket - Ø 5 mm shielded tulip contacts - 2 modules
<input type="checkbox"/> N4085 <input type="checkbox"/> NT4085 <input type="checkbox"/> L4085		2P+E 16 A 127/250 Va.c. universal duplex socket - shielded tulip contacts - 3 modules
Item		MULTI-STANDARD
<input type="checkbox"/> N4139 <input type="checkbox"/> NT4139 <input type="checkbox"/> L4139		2P+E A 250 Va.c. 15 A socket - multistandard - 2 modules
Item		USB CHARGER
<input type="checkbox"/> N4285C1 <input type="checkbox"/> NT4285C1 <input type="checkbox"/> L4285C1		USB connector 5 Vd.c. to recharge electronic devices as mobiles, smartphone, tablet and similar, up to 1100 mA. Power supply 230 Va.c.
<input type="checkbox"/> N4285C2 <input type="checkbox"/> NT4285C2 <input type="checkbox"/> L4285C2		USB connector 5 Vd.c. to quick recharge of a single electronic devices as mobiles, smartphone, tablet and similar, up to 2400 mA, or simultaneous recharge of two devices up to 1200 mA each port. Power supply 230 Va.c.
<input type="checkbox"/> L4286C1 <input type="checkbox"/> N4286C1 <input type="checkbox"/> NT4286C1		LL - type c usb charger - 1.1a
<input type="checkbox"/> L4286C2 <input type="checkbox"/> N4286C2 <input type="checkbox"/> NT4286C2		LL - type c double usb charger 2.4a 5v dc
<input type="checkbox"/> L5287C2 <input type="checkbox"/> N5287C2 <input type="checkbox"/> NT5287C2		LL - type a+c double usb charger 2.4a 5v dc
Item		RJ11 TELEPHONE CONNECTORS
<input type="checkbox"/> N4258/11N <input type="checkbox"/> NT4258/11N <input type="checkbox"/> L4258/11N		These connectors have been designed for meeting the requirements of telephone connections. RJ11, Toolless.

## MULTI-MEDIA SOCKETS



Item		MULTI-MEDIA SOCKETS
<input type="checkbox"/> N4294 <input type="checkbox"/> NT4294 <input type="checkbox"/> L4294		connector for loudspeakers
<input type="checkbox"/> N4269HJT <input type="checkbox"/> NT4269HJT <input type="checkbox"/> L4269HJT		connector - jack 3.5
<input type="checkbox"/> N4269RWT <input type="checkbox"/> NT4269RWT <input type="checkbox"/> L4269RWT		connector - RCA x 2
<input type="checkbox"/> N4269VGAT <input type="checkbox"/> NT4269VGAT <input type="checkbox"/> L4269VGAT		connector - HD15
<input type="checkbox"/> N4269RWYT <input type="checkbox"/> NT4269RWYT <input type="checkbox"/> L4269RWYT		RCA x 3 connector
<input type="checkbox"/> N4269HDMIT <input type="checkbox"/> NT4269HDMIT <input type="checkbox"/> L4269HDMIT		HDMI connector
<input type="checkbox"/> N4269USBT <input type="checkbox"/> NT4269USBT <input type="checkbox"/> L4269USBT		USB connector
Item		RJ45 CONNECTORS
		RJ 45 data transmission/telephone connectors. Specially designed for data and telephone transmission. These connectors are widely used for computer networks with a 4-pair cable.
		<b>Category</b> <b>Connection Type</b>
<input type="checkbox"/> N4279C5e <input type="checkbox"/> NT4279C5e <input type="checkbox"/> L4279C5e		5e UTP      Toolless IDC
<input type="checkbox"/> N4279C6 <input type="checkbox"/> NT4279C6 <input type="checkbox"/> L4279C6		6 UTP      Toolless IDC
<input type="checkbox"/> N4279C6A <input type="checkbox"/> NT4279C6A <input type="checkbox"/> L4279C6A		6A STP      Toolless IDC

# DIMMERS

For an efficient management of all main types of loads

## NEW UNIVERSAL DIMMER

With the new BTicino universal dimmers it is possible to control and adjust the light intensity of all types of loads on the market, from traditional incandescent lamps, to the latest generation LED and CFL energy saving lamps that, as required by the regulations, will soon replace them.



## INSTALLATION ADVANTAGES:

- thanks to the possibility of managing all kinds of loads, the device may be installed before selecting the lamps
- wiring only requires 2 wires (no neutral wire necessary), saving time during the installation
- as the neutral is not necessary, it can be easily installed in replacement of traditional existing dimmers or controls
- it can be controlled by one or more remote pushbuttons

## COMFORT:

- thanks to the new universal dimmer, it is possible to adjust the light intensity, obtaining the optimum light conditions for each situation
- its ergonomics and the user interface are simple and intuitive, with dedicated pushbuttons for switching on/off, and +/- level adjustment
- a simple touch is enough to switch the light on at a preset level (33% or 66%)

## ADD PUSH BUTTONS FOR MORE CONTROL POINTS



*Dimmer Control*



*Additional push button*

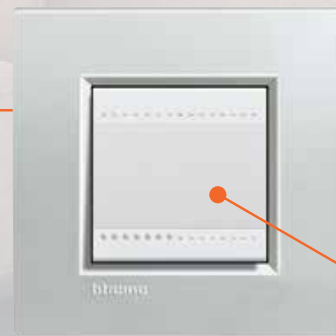

*"Press and Dimm"*

*Additional push button*

# DIMMERS



**ENERGY**  
EFFICIENCY



Respect for the environment,  
Saving energy without compromising  
your life comfort: today it's possible.

Item	0-10 V DIMMER
<input type="checkbox"/> N4410N	Dimmer output 0 - 10 V with electronic protection - 2 modules
<input type="checkbox"/> NT4410N	
<input type="checkbox"/> L4410N	
<b>UNIVERSAL DIMMER</b>	
<input type="checkbox"/> N4411N	Universal dimmer (resistive-inductive, capacitive, fluorescent compact and dimmable LEDs) - 75/200/200 W with electronic protection - 2 modules
<input type="checkbox"/> NT4411N	
<input type="checkbox"/> L4411N	

**Lower consumption, same light performances**

With a lighting performance equals to 100W (100W consumption with incandescent bulbs = 70W halogen = 17W LED), it is possible to save up to 65% by setting the dimmer to 25%.



**ADJUST THE LIGHT LEVEL WITH MAXIMUM EFFICIENCY**  
With the universal dimmer, it is also possible to control compact fluorescent lamps and LEDs, saving up to 65% of the electrical consumption.

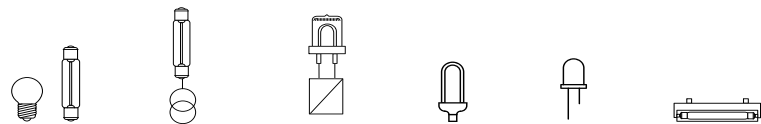

Loads									
Item	Type	Frequency	Supply	Incandescents and halogens	Halogens with ferromagnetic transformer	Halogens with electronic transformer	Dimmable compact fluorescents	Dimmable LED lamps	Fluorescents with electronic 0-10 V ballast
N4410N NT4410N L4410N	0 - 10 V	50 - 60 Hz	240 Va.c. 127 Va.c.						20 - 600 VA 20 - 300 VA
N4411N NT4411N L4411N	Universal	50 - 60 Hz	240 Va.c. 127 Va.c.	3 - 400 W 3 - 200 W	3 - 400 VA 3 - 200 VA	3 - 400 VA 3 - 200 VA	3 - 75 VA 3 - 37 VA	3 - 75 VA 3 - 37 VA	

# NEW TV SOCKETS

A simple range for advanced performances

## OPTIMUM PERFORMANCES AND CONFORMITY

Low attenuation, optimised over the requirements of the EN50083-4 standard (<1 dB in DVBT and Satellite Band). Suitable also for the new television devices in UHD (Ultra High Definition). Reduction of the amplification required for the operation.

All new TV sockets comply with European reference standards (EN 50083-2, EN 50083-4)

## Only one code for each TV socket

Simplification: for all the TV sockets, the aesthetic covers are supplied with the engine.

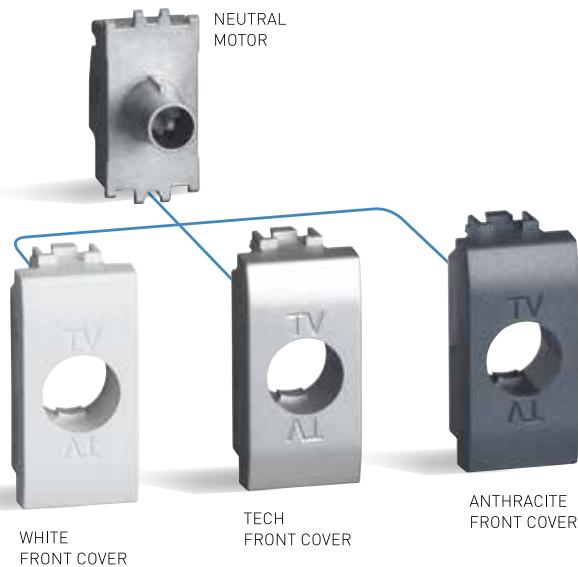

## A complete range

The new TV sockets offer is perfectly suitable for different installation modes of a TV system (single home or apartment block) and for the different wiring modes (star or passthrough installations).

Item	TV SOCKET
OLN4202D	Star coaxial for single-user aerial systems, also remote powered and centralised, and single-user/centralised satellite systems with current selection: shielded transfer for channels selection: shielded connection clamps with captive screws - Ø 0.5mm: male connector - supplied in package with common mechanism and, where provided, with front covers in different aesthetics finishes.

Item	TYPE F SAT SOCKET
OLN4202F	Type-F coaxial socket - impedance 75 ohm - screw hook - supplied in package with common mechanism and front covers in different aesthetic finishes - 1 module

Item	PLUG
OS2133	Plugs, mobile TV jacks and terminal resistance Mobile TV plug and jack - Ø 9,5 mm - white - for TV + SAT jacks and N/NT4206D
O75RTN	Terminal resistance for line closing 750 impedance in installations with cascade connection - to be added to the last pass-through jack

# NEW INDUCTION AND USB CHARGERS

Faster charging and maximum flexibility for all uses

## MORE SOLUTIONS FOR ANY ROOM

The USB chargers, suitable for smartphones, Mp3 players, navigators, tablets etc., guarantee a fast charge and greater power, adapting perfectly to the energy requirements of latest-generation batteries. Moreover, thanks to the variety of chargers proposed in the catalogue, they guarantee maximum flexibility of use, adapting to every need and every room.

## Flexibility of use

From the private home to the office, from the hotel to common areas BTicino USB chargers satisfy modern charging needs for every device.

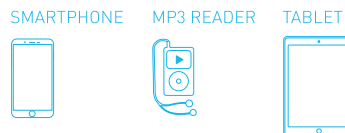

**SUITABLE** for all rooms thanks to their small size. Recommended in the bedroom or kitchen.

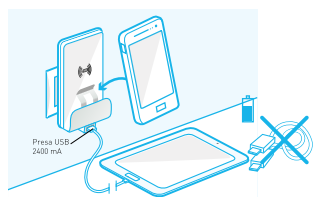

For wireless induction charging of devices fitted with suitable receivers. Also has a USB 2,400 mA socket



**RECOMMENDED** on the kitchen worktop, in the living room, hotel ... Thanks to the support and induction charge.

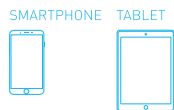

Item	INDUCTION CHARGER
■ LN5285CW2	Induction charger, with 2,400 mA USB charging port. It allows fast and wireless charging of smartphones equipped with an induction receiver. Suitable for bed head, sideboards, desks, work environments. Complies with the WPC Qi standard (World

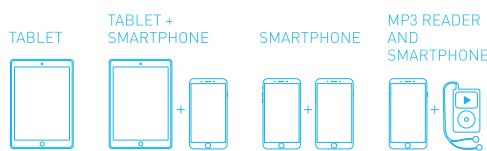

**WHEN** you have several telephones to charge or you need a rapid charge. Ideal for the living room or office.





#### ENERGY MANAGEMENT

- Temperature control
- Load management
- Consumption display

# MyHOME\_Up

With Livinglight  
the best in  
digital technology

#### ADVANCED ELECTRICAL SYSTEMS

MyHOME\_Up is the high technology BTicino home automation system for the more advanced electric systems in terms of comfort, safety, energy savings, audio/video communication and local or remote control.

#### AN OPEN SYSTEM

Thanks to the MyHOME\_Link integration platform based on use of the Driver manager item F459 and the TCP/IP communication protocol, MyHOME\_Up can be integrated with the best technologies and systems and devices from other producers.



**COMFORT**

- Light automation
- Automatic devices and shutter management
- Sound system



**LOCAL AND REMOTE CONTROL**

- Local or remote management using the MyHOME\_Up application for iOS and Android smartphones and tablets.



**VIDEO DOOR ENTRY SYSTEM**

- Call repetition on smartphone
- Video control



**SAFETY**

- Burglar alarm
- Technical alarms
- Video control



MyHOME Alarm APP

**MyHOME Alarm and MyHOME\_Up are free and available on**



**VIDEO DOOR ENTRY SYSTEM, LOCAL CONTROL AND INTEGRATION**

- Scenario activation
- Function integration
- Control of video door entry functions

HOMETOUCH - Touch Screen 7"

# IN THE HOTEL LIKE AT HOME



**NEW**  
OUTSIDE THE ROOM "DO NOT DISTURB -  
MAKE UP ROOM" PILOT LAMP WITH  
DIFFUSER, DOORBELL AND BADGE READER



INSIDE THE ROOM: DO NOT DISTURB  
- MAKE UP THE ROOM" PUSHBUTTONS,  
AND SUPPLY BADGE POCKET (NETWORK ON)



## MANAGEMENT OF THE ROOMS AND THE COMMON AREAS

The Guest Room Management System offer gives the possibility of supervising and controlling in real time the status of the rooms, and interact with them.

## IMMEDIATELY AT EASE

The presence of a badge holder socket invites the guest to immediately interact with the room services on offer. To be left undisturbed simply press the "do not disturb" control.



Maximum attention to customer requirements  
in terms of: available services, comfort  
simple interaction with products and functions



SHAVER SOCKET



**NEW**  
DIGITAL THERMOSTAT,  
MyHOME



**NEW**  
8 KEYS MyHOME CONTROL  
(CUSTOMISABLE)

**EXTRA ATTENTION TO SAFETY**

Step marker lamps for the night, alarm pull cords and protected razor sockets to ensure maximum safety at all times.

**THE RIGHT ATMOSPHERE, IN ONE MOVE**

Thanks to the new MyHOME devices - control with the 8 keys (customisable) and digital thermostat installed at the Digital thermostat, MyHOME side of the bed; with a single touch it is possible to recreate the desired atmosphere, adjusting the light, the temperature, and the shutters.



HDMI AND USB CONNECTOR FOR  
MANAGING READERS AND ELECTRONIC  
DEVICES SUCH AS DVDS, DIGITAL CAMERAS,  
MP3 READERS



CURTAIN ADJUSTMENT,  
BED HEADBOARD AND BEDSIDE  
CABINET LIGHTS MANAGEMENT

**A complete offer  
for a state of the  
art electric system  
also in the hotel room**

**CONNECTION, ENTERTAINMENT,  
AND MULTIMEDIAILITY**

A range of products dedicated to audio/video connections provide the desired level of entertainment and relax.

**EACH FUNCTION CAN BE  
RECOGNISED IMMEDIATELY**

A range of backlit masks with simple and intuitive symbols make each control recognisable and, and make it easier for the customer to interact with the available functions.

# HOTEL OFFER



LN4549



NT4551



NT4301/16



NT4305/16



L4536



N4033



N4177



N4373H



N4441

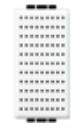

N4351/230



NT4355/12



L4356/230

Item	BADGE-HOLDER POCKET
<input type="radio"/> LN4549	badge holder pocket for the power supply inside the hotel room - slot light with built-in lamp - 30 second switch-off delay - power supply 230 Va.c. - 2 modules - to be completed with front cover in the desired look
<input type="radio"/> LN4548	badge holder pocket for the power supply inside the hotel room with RFID technology recognition - slot light with built-in lamp - 30 second switch-off delay - power supply 230 Va.c. - 2 modules - to be completed with front cover in the desired look

\*Note: Through Domestic Contractor

	FRONT COVERS FOR BADGE-HOLDER POCKETS
<input type="checkbox"/> N4551	front cover for traditional badge-holder or My Home - SCS - 3 module the installation is compatible with 3 module box only
<input type="checkbox"/> NT4551	
<input type="checkbox"/> L4551	

	AUTOMATIC THERMAL MAGNETIC CIRCUIT BREAKERS
<input type="checkbox"/> N4301/16	circuit breakers as above 16A - breaking capacity 3000 A 230 Va.c.
<input type="checkbox"/> NT4301/16	
<input type="checkbox"/> L4301/16	

	GROUND FAULT CIRCUIT INTERRUPTER (GFCI)
<input type="checkbox"/> N4305/16	2 modules earth leakage protection 16A 3kA - sensitivity: 10mA - 230 Va.c. - contacts open or closed indicator - test pushbutton - breaking power 1 500 A 230 Va.c.
<input type="checkbox"/> NT4305/16	
<input type="checkbox"/> L4305/16	

	SURGE PROTECTION DEVICE
<input type="checkbox"/> N4536	1P surge protection device to be combined with the users mains socket - rated discharge voltage $I_n=1$ kA - max. current $I_{max}=2$ kA - max. protection voltage $U_p=1$ kV - rated voltage $U_n=110-230$ Va.c. - max. permanent voltage $U_c=250$ Va.c.
<input type="checkbox"/> NT4536	
<input type="checkbox"/> L4536	

Item	LAMPHOLDER FOR OFF-DOOR SIGNALLING
<input type="checkbox"/> N4373H	off-door lampholder with double optical signalling; do not disturb and make-up the room - use 2 LEDs item LN4742v12T (12V)
<input type="checkbox"/> NT4373H	
<input type="checkbox"/> L4373H	

	SHAVER SOCKET
<input type="checkbox"/> N4177	shaver socket with insulation transformer - input voltage 230 Va.c. at 50/60 Hz - output voltage 115/230 Va.c. 20 VA
<input type="checkbox"/> NT4177	
<input type="checkbox"/> L4177	

\*Note: when installed with Livinglight AIR, the use of the box extension is necessary, in order to make easy the wiring

	CORD PUSH BUTTON
<input type="checkbox"/> N4033	cord pushbutton 1 P NO 1D A for bathroom alarm
<input type="checkbox"/> NT4033	
<input type="checkbox"/> L4033	

	ELECTRONIC THERMOSTAT
<input type="checkbox"/> N4441	electronic room thermostat - relay output with 1 switching contact 2 A 250 Va.c. - power supply 230 Va.c.
<input type="checkbox"/> NT4441	
<input type="checkbox"/> L4441	

	BELLS
<input type="checkbox"/> N4351/230	bronze bell 230 Va.c. - 8 VA - 80 dB - 50 and 60 Hz
<input type="checkbox"/> NT4351/230	
<input type="checkbox"/> L4351/230	

<input type="checkbox"/> N4355/12	electronic bell - 3 different sounds - with front volume adjustment - 12 Va.c./d.c. - 2 modules
<input type="checkbox"/> NT4355/12	
<input type="checkbox"/> L4355/12	

	BUZZERS
<input type="checkbox"/> N4356/230	buzzer 230 Va.c. - 8 VA - 75 dB - 50 and 60 Hz
<input type="checkbox"/> NT4356/230	
<input type="checkbox"/> L4356/230	

# LIGHTING DEVICES AND EMERGENCY LAMPS



Item	PILOT LIGHTS
<input type="checkbox"/> N4371T <input type="checkbox"/> NT4371T <input checked="" type="checkbox"/> L4371T	lampholder with transparent diffuser - for LED items LN4742V12T, LN4742V127T and LN4742V230T
<input type="checkbox"/> N4371R <input type="checkbox"/> NT4371R <input checked="" type="checkbox"/> L4371R	lampholder with red diffuser - for LED items LN4742V12T, LN4742V127T and LN4742V230T
<input type="checkbox"/> N4371V <input type="checkbox"/> NT4371R <input checked="" type="checkbox"/> L4371V	lampholder with green diffuser - for LED items LN4742V12T, LN4742V127T and LN4742V230T
<input type="checkbox"/> N4372AV <input type="checkbox"/> NT4372AV <input checked="" type="checkbox"/> L4372AV	double lampholder with 2 diffuser: 1 orange + 1 green - for 2 LED items LN4742V12T, LN4742V127T and LN4742V230T
<b>SIGNALLING LAMP</b>	
○L4374V12V24	signalling lamp with white light LED - 12/24 Va.c.
○L4374/230	signalling lamp with white light LED - 230 Va.c.
<b>OFFDOOR LIGHT UNITS WITH LAMP</b>	
Note: for all models we recommend a mounting height between 160 and 205sm (wall protrusion 52 mm)	
<input type="checkbox"/> L4385/230R <input type="checkbox"/> L4385/230V <input checked="" type="checkbox"/> L4385/230B	power supply 230V - red (R), green (V), white (B)
○L4745/230	spare lamp E10 230V - 5 W

Item	EMERGENCY LIGHT
○L4386/3/127*	emergency light as above - 3 h life

Item	REMOVABLE LAMP
○LN4380N	Pull-out and rechargeable torch with automatic switching on device - It lights up automatically whrn there is a power cut - push&pull pull-out system complete with recharge base - white light LED with high luminous efficiency - ON/OFF switch and SPOT pushbutton to increase the brightness when necessary - interchangeable Ni-MH batteries without memory e ect - 2 hour life - low consumption in stand-by 0.4 W - 230 Va.c. power supply - 2 modules. Supplied with neutral base and front cover plates in white, tech, anthracite colours
○4380NB	spare batteries for removable torch

Item	STEP MARKER LAMPS
○L4382V12V24	Step marker lamps with white light LEDs - 12 -24 Va.c. - on-o switch- 0.6W at 12 Va.c. - 0.8 W at 24 Va.c.
○L4382/230	Step marker lamps with white light LEDs - 230 Va.c. - on-o switch - 0.5 W



# MEDIA HUB

SEAMLESS CONNECTION



# MEDIA HUB, HANDY CONNECTION...

The ideal solution for today's guests who require increasing connectivity

The Media Hub provides connectivity in a single, compact unit, for the maximum convenience of your guests. They can connect their electronic devices to make full use of all their multimedia content (music, films, photos, etc.). Increase the attractiveness of your hotel by providing these new types of function.

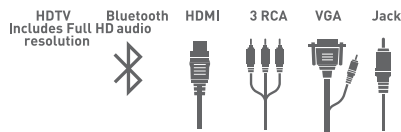
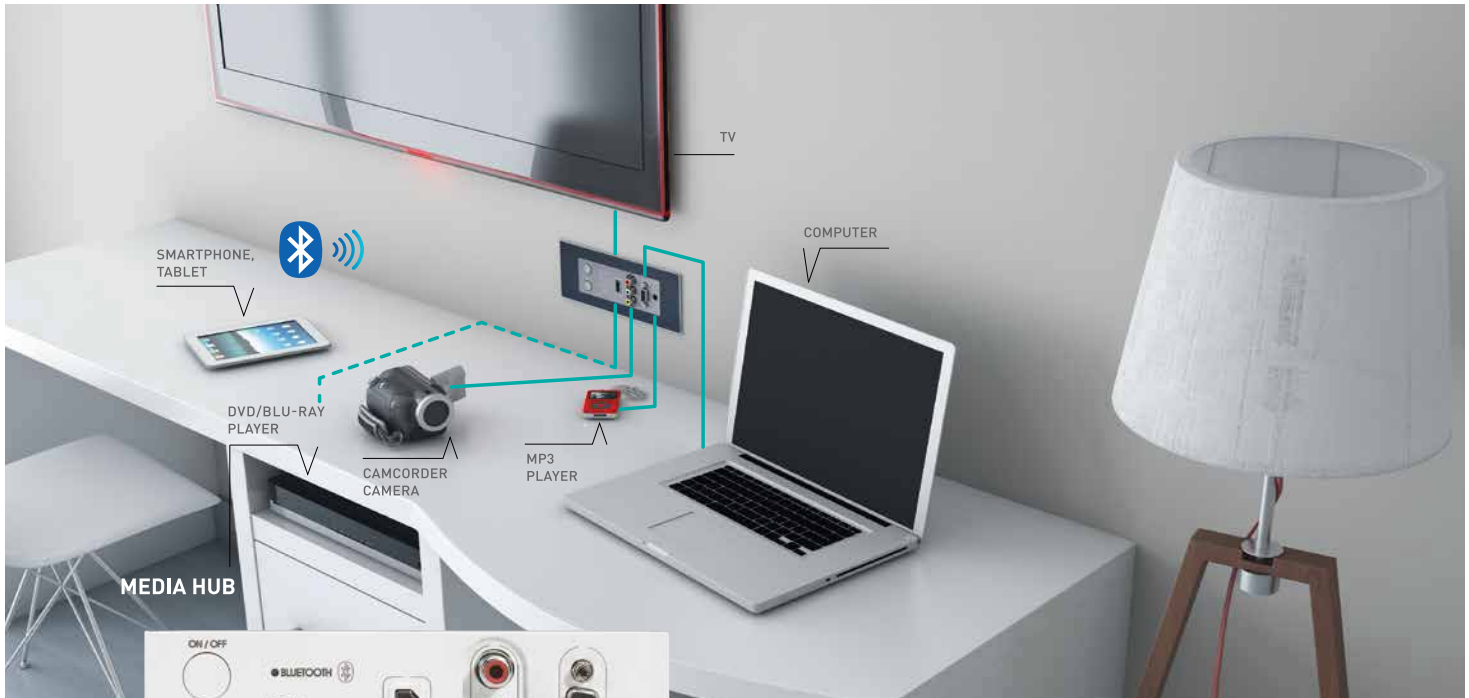

## Audio/video system



5 720 68



5 725 68

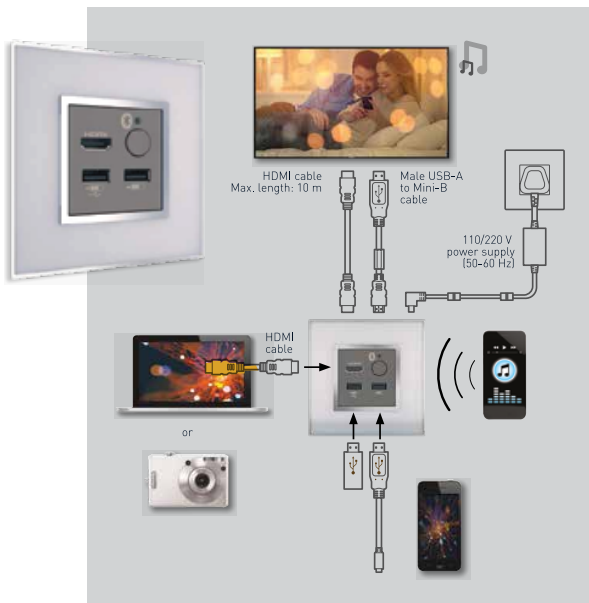

Pack	Cat. No.
1	5 720 68
1	5 725 68
1	5 722 69
1	5 727 69

### Media Hub

For connecting various types of audio/video device (computer, camera, camcorder, Blu-ray player, mp3 player, games console, smartphone, etc.) to a single product so that these media can be played on a TV

Ideal for giving users access to the main audio/video socket standards (HDMI, RCA, composite video, HD15 + Jack) if there is a TV attached to a wall or a piece of furniture

The Bluetooth function enables users to play music from a mobile device (smartphone, tablet, etc.) through the TV's loudspeakers

The Media Hub is connected to the TV via an HDMI cord (max. length: 10 m) and powered via a terminal block (110/220 VAC).

Inputs: HDMI, 3 RCA, HD15 + 3.5 m Jack, Bluetooth audio

Output: HDMI

6 modules

- White
- Magnesium
- White
- Magnesium

# LIGHT COVER PLATES

## METALS

Material : zamak



Ice gold - OA



Bronze - BZ



Nickel - NS



Steel - AC



Moonlight - GL

## NATURALIA

Material : zamak



Native - NA



Silver - AG

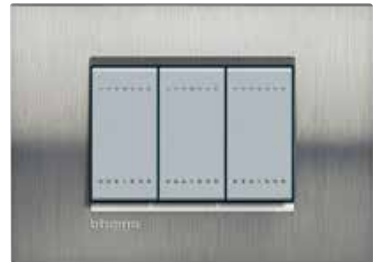

Brushed steel - ACS

## SILK

Material : zamak



Park - PK



Square - SQ

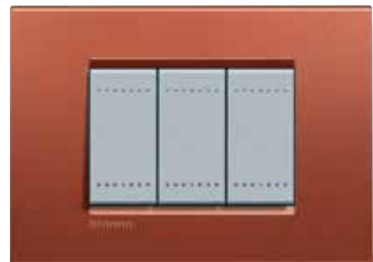

Brick - RK



Avenue - AE



Club - CB

**SQUARE COVER PLATE CODES**  
 2 modules - LNA4802...  
 2 modules centered - LNA4819...  
 3 modules - LNA4803...  
 4 modules - LNA4804...  
 7 modules - LNA4807...  
 3+3 modules - LNA4826...



**DEEP**

Material : polymer plastic



Green - VD



Orange - OD

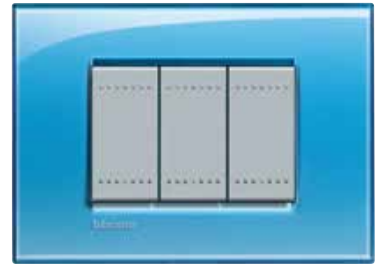

Blue - AD

**KRISTAL**

Material : polymer plastic



London fog - KP



Acquamarine - KA



Cold grey - KG

**NEUTRAL**

Material : polymer plastic



Anthracite - AR



White - BI



Tech - TE

**ESSENCES**

Material : solid wood



Cherrywood - LCA



























Bamboo - LBA



Walnut - LNC

# LIGHT COVER PLATES

## TABLE FOR SELECTING CODES

MODULES							
		2	2 centered	3	4	7	3 + 3
<b>METALS (zamak)</b>							
	Ice Gold	LNA48020A	LNA48190A	LNA48030A	LNA48040A	LNA48070A	LNA48260A
	Bronze	LNA4802BZ	LNA4819BZ	LNA4803BZ	LNA4804BZ	LNA4807BZ	LNA4826BZ
	Nickel	LNA4802NS	LNA4819NS	LNA4803NS	LNA4804NS	LNA4807NS	LNA4826NS
	Steel	LNA4802AC	LNA4819AC	LNA4803AC	LNA4804AC	LNA4807AC	LNA4826AC
	Moonlight Silver	LNA4802GL	LNA4819GL	LNA4803GL	LNA4804GL	LNA4807GL	LNA4826GL
<b>NATURALIA (zamak)</b>							
	Native	LNA4802NA	LNA4819NA	LNA4803NA	LNA4804NA	LNA4807NA	LNA4826NA
	Silver	LNA4802AG	LNA4819AG	LNA4803AG	LNA4804AG	LNA4807AG	LNA4826AG
	Brushed Steel	LNA4802ACS	LNA4819ACS	LNA4803ACS	LNA4804ACS	LNA4807ACS	LNA4826ACS
<b>SILK (zamak)</b>							
	Park	LNA4802PK	LNA4819PK	LNA4803PK	LNA4804PK	LNA4807PK	LNA4826PK
	Square	LNA4802SQ	LNA4819SQ	LNA4803SQ	LNA4804SQ	LNA4807SQ	LNA4826SQ
	Brick	LNA4802RK	LNA4819RK	LNA4803RK	LNA4804RK	LNA4807RK	LNA4826RK
	Avenue	LNA4802AE	LNA4819AE	LNA4803AE	LNA4804AE	LNA4807AE	LNA4826AE
	Club	LNA4802CB	LNA4819CB	LNA4803CB	LNA4804CB	LNA4807CB	LNA4826CB
<b>DEEP (polymer plastic)</b>							
	Green	LNA4802VD	LNA4819VD	LNA4803VD	LNA4804VD	LNA4807VD	LNA4826VD
	Orange	LNA4802OD	LNA4819OD	LNA4803OD	LNA4804OD	LNA4807OD	LNA4826OD
	Blue	LNA4802AD	LNA4819AD	LNA4803AD	LNA4804AD	LNA4807AD	LNA4826AD
<b>KRISTALL (polymer plastic)</b>							
	London fog	LNA4802KF	LNA4819KF	LNA4803KF	LNA4804KF	LNA4807KF	LNA4826KF
	Aquamarine	LNA4802KG	LNA4819KG	LNA4803KG	LNA4804KG	LNA4807KG	LNA4826KG
	Cold grey	LNA4802KA	LNA4819KA	LNA4803KA	LNA4804KA	LNA4807KA	LNA4826KA
<b>NEUTRAL (polymer plastic)</b>							
	Anthracite	LNA4802AR	LNA4819AR	LNA4803AR	LNA4804AR	LNA4807AR	LNA4826AR
	White	LNA4802BI	LNA4819BI	LNA4803BI	LNA4804BI	LNA4807BI	LNA4826BI
	Tech	LNA4802TE	LNA4819TE	LNA4803TE	LNA4804TE	LNA4807TE	LNA4826TE
<b>WOOD</b>							
	Cherrywood	LNA4802LCA	LNA4819LCA	LNA4803LCA	LNA4804LCA	LNA4807LCA	LNA4826LCA
	Bamboo	LNA4802LBA	LNA4819LBA	LNA4803LBA	LNA4804LBA	LNA4807LBA	LNA4826LBA
	Walnut	LNA4802LNC	LNA4819LNC	LNA4803LNC	LNA4804LNC	LNA4807LNC	LNA4826LNC
<b>SUPPORTS</b>							
	Fixing with screws	LN4702	LN4719	LN4703	LN4704	LN4707	LN4726



# LIGHT AIR

## COVER PLATE COLOURS

**MONOCHROME**  
Material : zamak



Pure white - BN



Tech - TE



Anthracite - AR

**SHINY**  
Material : zamak



Pewter - PT



Polladium - PL



Satin Gold - OF



Satin Nickel - NK



Pearl White - PR

**SOFT**  
Material : zamak



NEW

Street - ST



NEW

Clay - CY



NEW

Sand - SB



NEW

Blue Moon - BM















**AIR COVER PLATE CODES**

- 2 modules - LNC4802...
- 3 modules - LNC4803...
- 4 modules - LNC4804...
- 7 modules - LNC4807...
- 3+3 modules - LNC4826...

# LIGHT AIR cover plate colours

## COVER PLATES: TABLE FOR SELECTING CODES

### Cover plate modules

	3	4	7	3+3	
<b>MONOCHROME (zamak)</b>					
	Pure white	LNC4803BN	LNC4804BN	LNC4807BN	LNC4826BN
	Tech	LNC4803TE	LNC4804TE	LNC4807TE	LNC4826TE
	Anthracite	LNC4803AR	LNC4804AR	LNC4807AR	LNC4826AR
<b>SOFT (zamak)</b>					
	Street	LNC4803ST	LNC4804ST	LNC4807ST	LNC4826ST
	Clay	LNC4803CY	LNC4804CY	LNC4807CY	LNC4826CY
	Sand	LNC4803SB	LNC4804SB	LNC4807SB	LNC4826SB
	Blue moon	LNC4803BM	LNC4804BM	LNC4807BM	LNC4826BM
<b>SHINY (zamak)</b>					
	Pewter	LNC4803PT	LNC4804PT	LNC4807PT	LNC4826PT
	Palladium	LNC4803PL	LNC4804PL	LNC4807PL	LNC4826PL
	Satin gold	LNC4803OF	LNC4804OF	LNC4807OF	LNC4826OF
	Satin nickel	LNC4803NK	LNC4804NK	LNC4807NK	LNC4826NK
	Pearl white	LNC4803PR	LNC4804PR	LNC4807PR	LNC4826PR
<b>BRUSHED (zamak)</b>					
	brushed nickel	LNC4803NIS	LNC4804NIS	LNC4807NIS	LNC4826NIS
	Brushed titanium	LNC4803TIS	LNC4804TIS	LNC4807TIS	LNC4826TIS
	brushed chrome	LNC4803CRS	LNC4804CRS	LNC4807CRS	LNC4826CRS
<b>Supports</b>					
Supports	LN4703C	LN4704C	LN4707C	LN4726C	

## LIGHT AIR

LIVINGLIGHT AIR features reduced protrusion from the wall of the device/cover plate.

- 3, 4, 7 and 3+3 module installation: traditional BTicino flush mounted boxes (503E), or boxes with minimum depth 50 mm.

### Suggestions:

- new systems: considering the back position of the mechanisms inside the boxes, for masonry walls the use of box extensions is recommended, for better comfort and wiring
- existing systems: check that the depth of the box is at least 50 mm.

#### PRODUCTS FOR WHICH THE USE OF THE BOX EXTENSION IS NECESSARY, WHEN INSTALLED WITH LIVINGLIGHT AIR

Box extension	Products to combine	Item
10 A 2 modules	resistive dimmer with built-in two-way switch - 1 module	N4402N NT4402N L4402N
	1 module resistive dimmer	N4406 NT4406 L4406
	10 A 1 module axial pushbutton + MH BASIC interface	N4055A NT4055A L4055A
	10 A 1 module axial pushbutton + MH BASIC interface	N4055M2A NT4055M2A L4055M2A
	230 Va.c. shaver socket	N4177 NT4177 L4177
	emergency lamp 3 hours - 4 modules	L4384/3
	emergency lamp 3 hours - 6 modules	L4386/3
	emergency lamp always on - 3 hours - 6 modules	L4386/3L

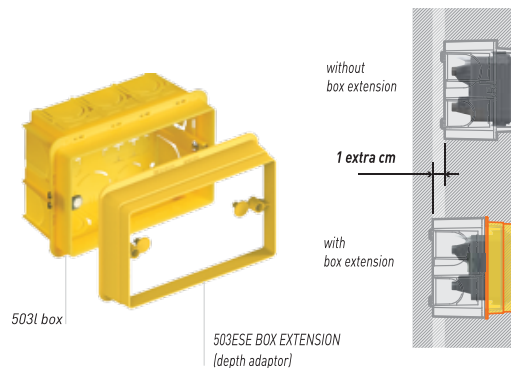

## ACCESSORIES



LN4742V12T



LN4742V230



N4950



L4951



NT4953

Item	LEDs
<input type="radio"/> LN4742V230 <input type="radio"/> LN4742V12	LED for rocker controls 230V or 12/24 V - amber
<input type="radio"/> OLN4742V230T <input type="radio"/> OLN4742V12T	white LED for pilot lights and BS 230 V or 12/24 V devices

Item	BLANK PLATES
<input type="checkbox"/> N4950 <input type="checkbox"/> NT4950 <input type="checkbox"/> L4950	blank plate - 1 module
<input type="checkbox"/> N4951 <input type="checkbox"/> NT4951 <input type="checkbox"/> L4951	blank plate with knockout - 2 modules
<input type="checkbox"/> N4953 <input type="checkbox"/> NT4953 <input type="checkbox"/> L4953	blank plate with output $\varnothing$ 9 mm - with clamp - 1 module



LN4702C



LN4703C



LN4704C



LN4707C



LN4726C

## SUPPORT FRAME



L4702



LN4702



LN4719\*



LN4726



LN4703



LN4704



LN4707

Item	PLASTIC SUPPORT FRAME - LIVING LIGHT
<input type="radio"/> L4702	2 modules support for Living International cover plates - screw fastening
<input type="radio"/> OLN4702	2 modules support for cover plates - screw fastening
<input type="radio"/> OLN4719	2 central modules support - for square cover plates, item LNA4819... - screw fastening
<input type="radio"/> OLN4703	3 modules support for LIVINGLIGHT cover plates - screw fastening
<input type="radio"/> OLN4704	4 modules support for round and square LIVINGLIGHT cover plates - screw fastening
<input type="radio"/> OLN4707	7 modules support for round and square LIVINGLIGHT cover plates - screw fastening
<input type="radio"/> OLN4726	3+3 modules support for round and square LIVINGLIGHT cover plates - screw fastening

Item	PLASTIC SUPPORT FRAME - LIGHT AIR
<input type="radio"/> OLN4702C	2 modules support for AIR cover plates series LNC... - screw fastening
<input type="radio"/> OLN4703C	3 modules support for AIR cover plates LNC... - screw fastening
<input type="radio"/> OLN4704C	4 modules support for AIR cover plates LNC... - screw fastening
<input type="radio"/> OLN4707C	7 modules support for AIR cover plates LNC... - screw fastening
<input type="radio"/> OLN4726C	3+3 modules support for AIR cover plates LNC... - screw fastening

# INSTALLATION SYSTEM

## 2 MODULES

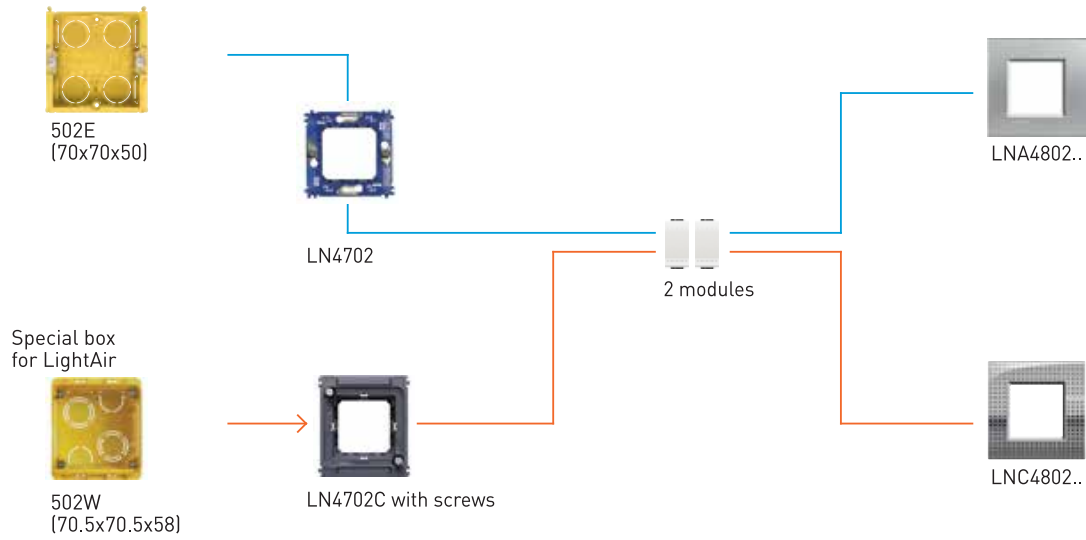

## 3 MODULES

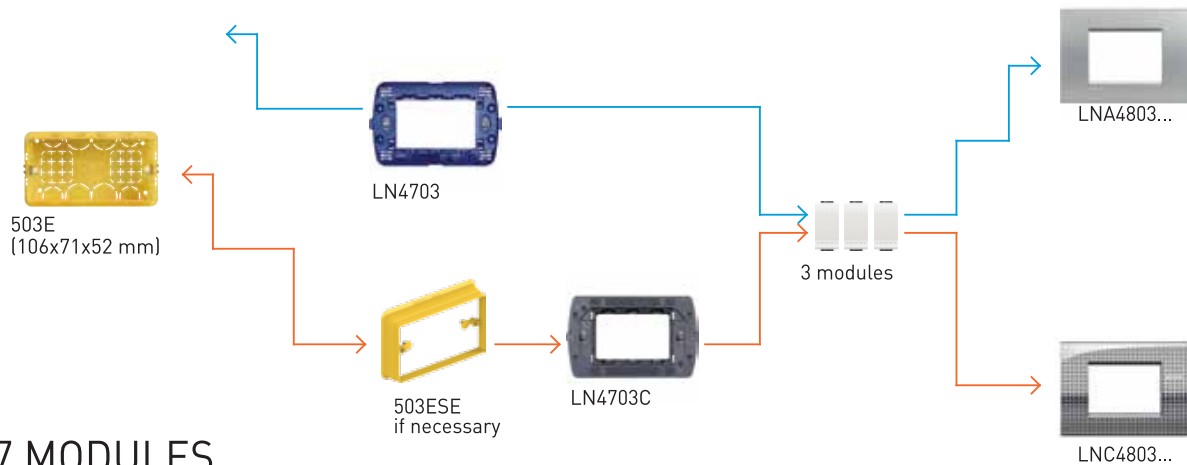

## 7 MODULES

